

Abril/2002

CHF 04

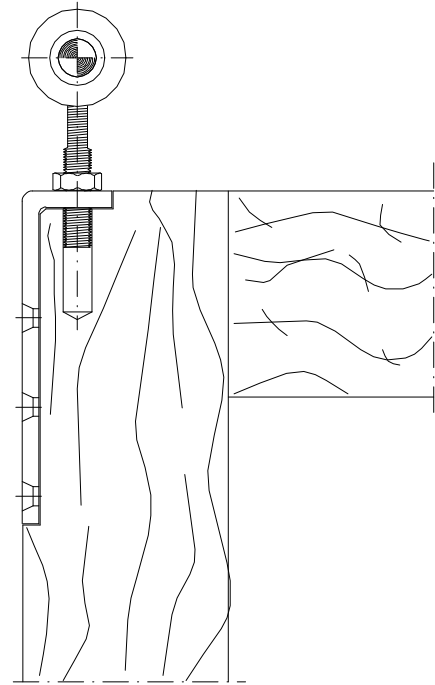
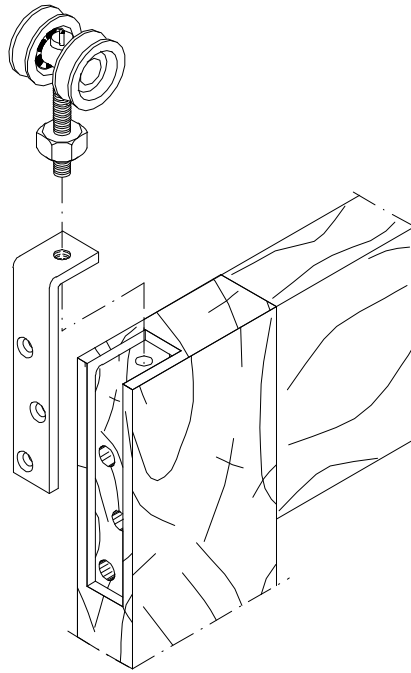

Perspectiva - sem escala

Instalação - escala 1:2

Medidas em milímetros

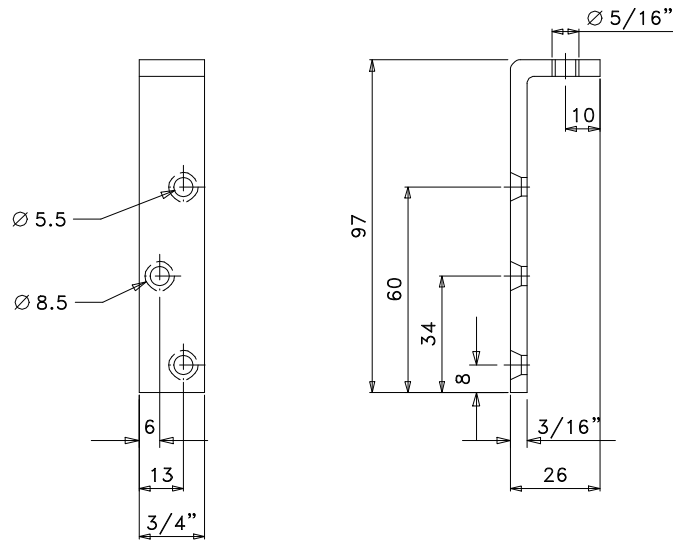

Vistas - escala 1:2

Composição

Chapa aço carbono

Parafuso de fixação aço carbono