

ROL83N
Carga: 260 kg p/folha

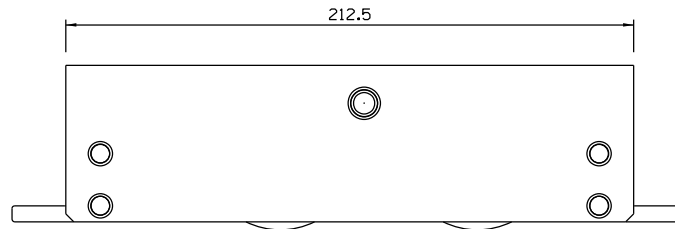

Vistas - escala 1:2

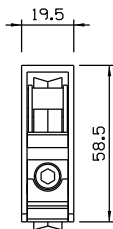
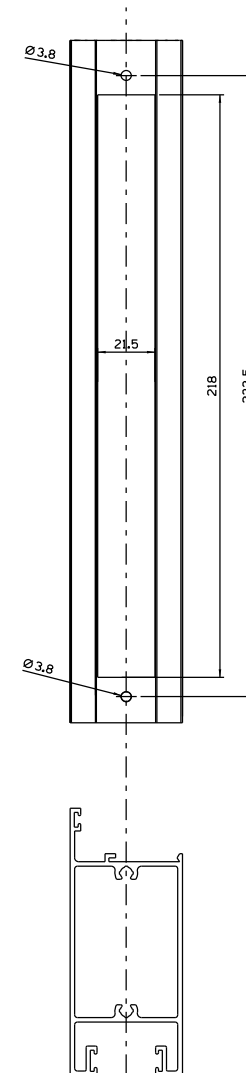

Usinagem - escala 1:2

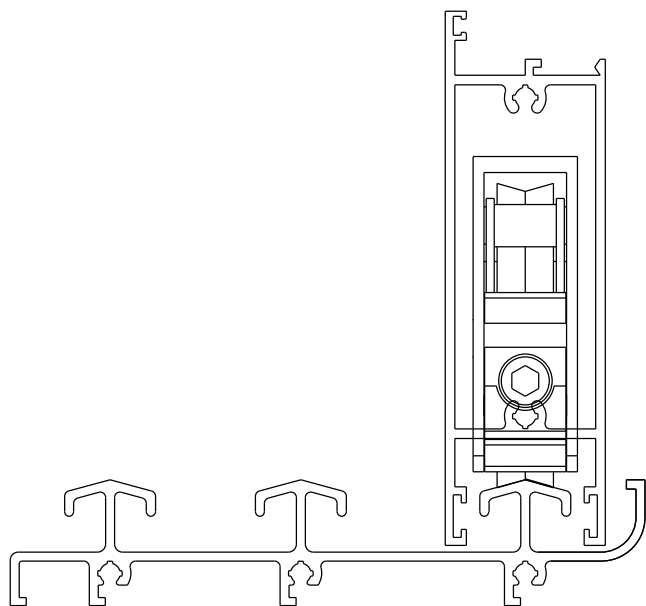

LINHA 30

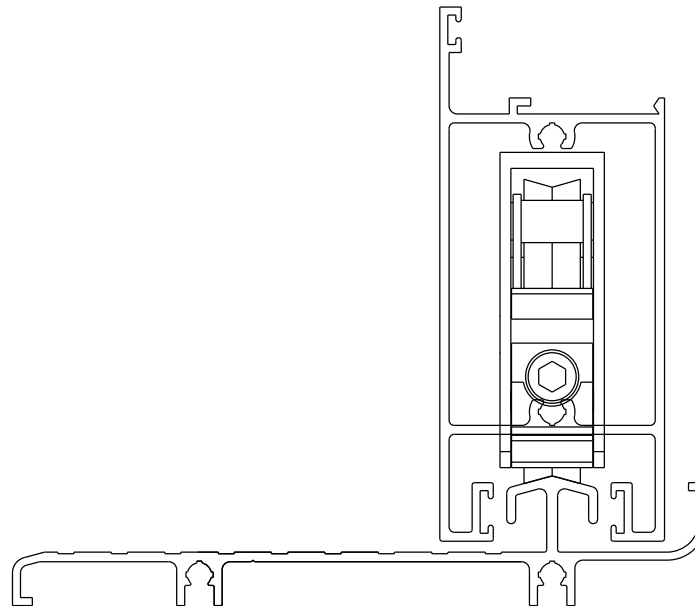

LINHA 42

Instalações - escala 1:1

- Composição
- Cavelete/suporte da roda e eixos alumínio
 - Roda c/rol.blindado revestido de nylon c/fibra
 - Parafusos de fixação inox
 - Embalagem: 02 pcs