

Maio/2017

FEC118

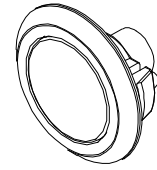

BAC01

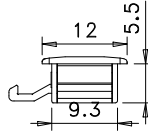
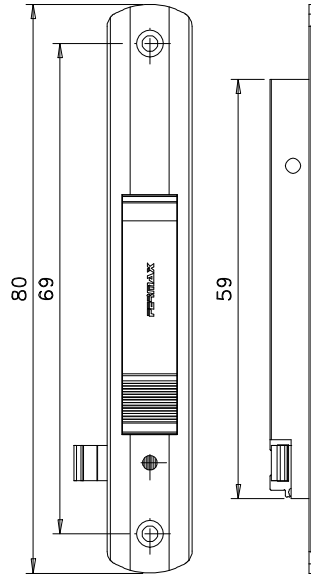
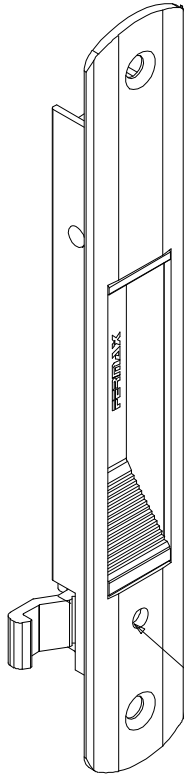

Vistas - escala 1:2

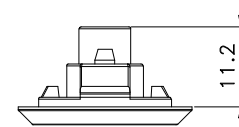

ESCALA 1:1

Usar chave Allen 3 mm

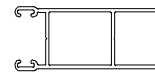

Medidas em milímetros

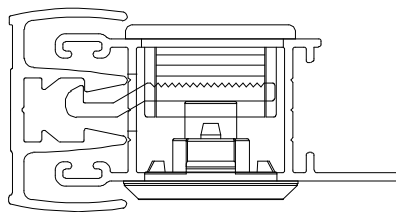

Instalação - escala 1:1

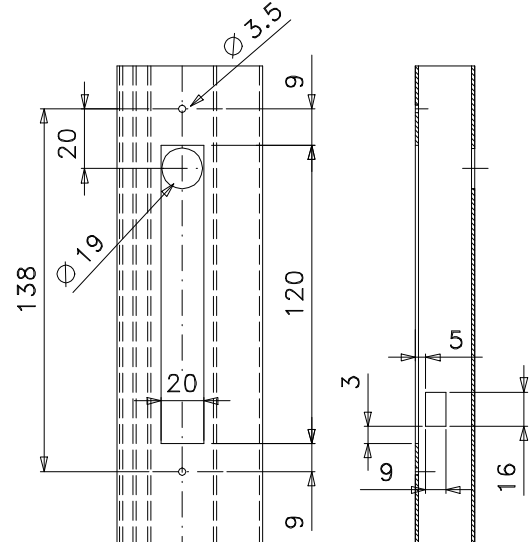

USINAGEM  
Sem escala

**Composição**

- Base/eixo/lingueta alumínio
- Mola aço
- Parafusos inox
- Contrafecho alumínio