

Março/2022

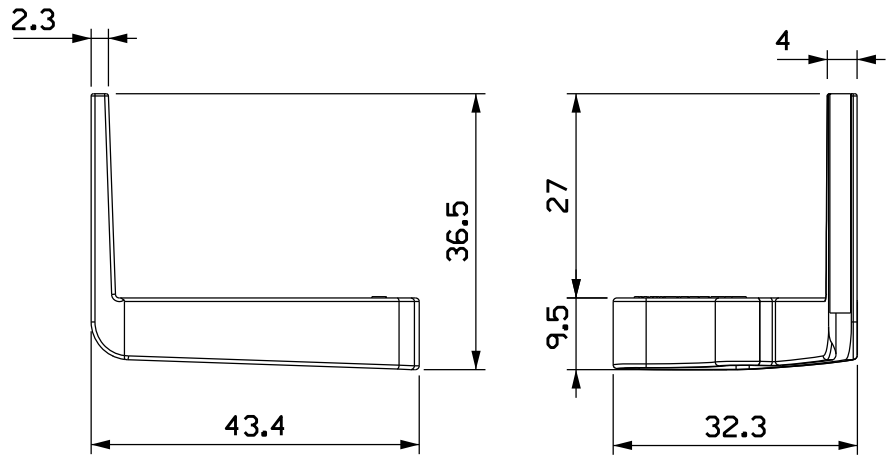

TMM79P021 (PTO)
TMM79P022 (BCO)

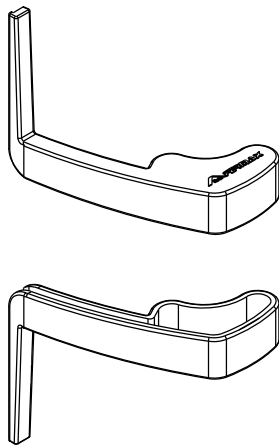
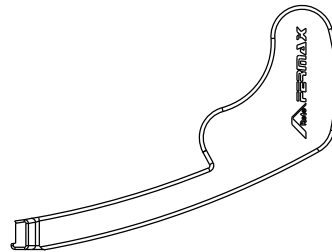

Vistas - escala 1:1

Medidas em milímetros

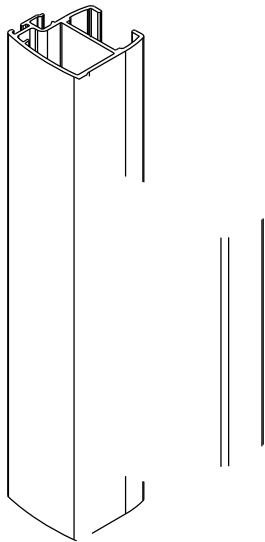

Instalação - escala 1:2

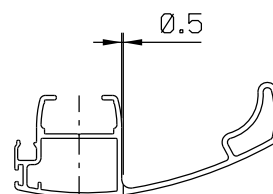
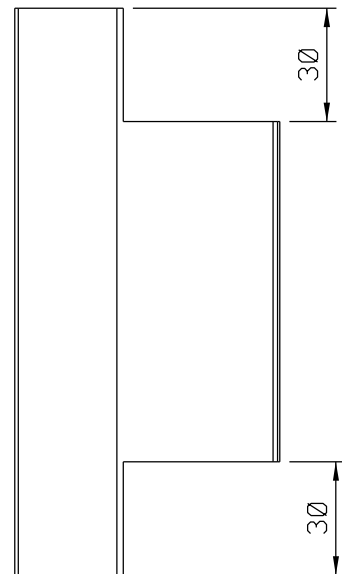

Vistas - escala 1:2

Composição
Nylon
Pack: 10 pares