

ROL37N c/ rolam. 40 Kg/folha  
 ROL38N s/ rolam. 15 Kg/folha

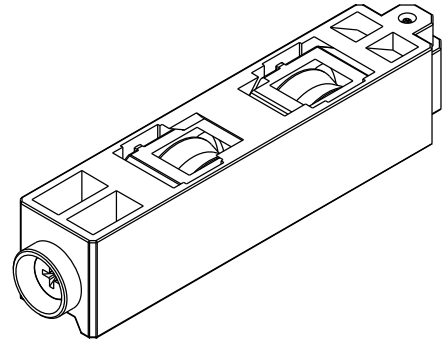

ROL39N c/ rolam. 80 Kg/folha

Setembro/2023

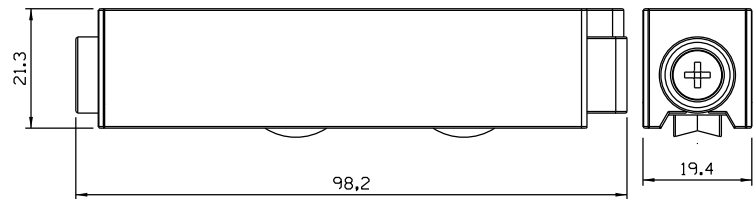
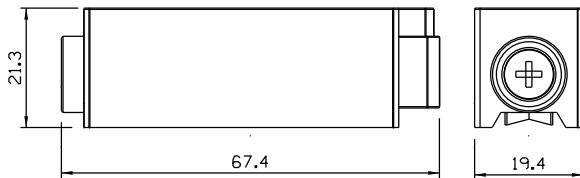
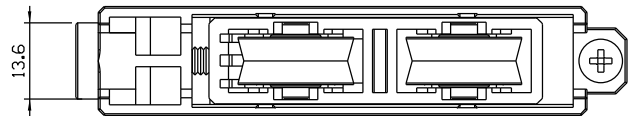
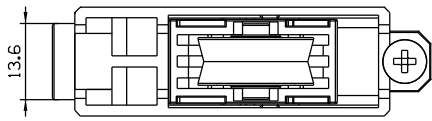

Vistas - sem escala

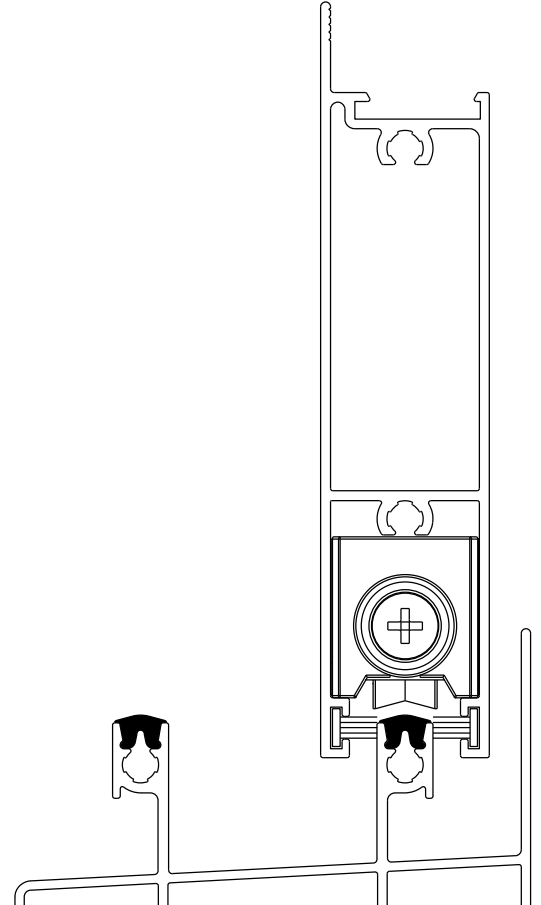
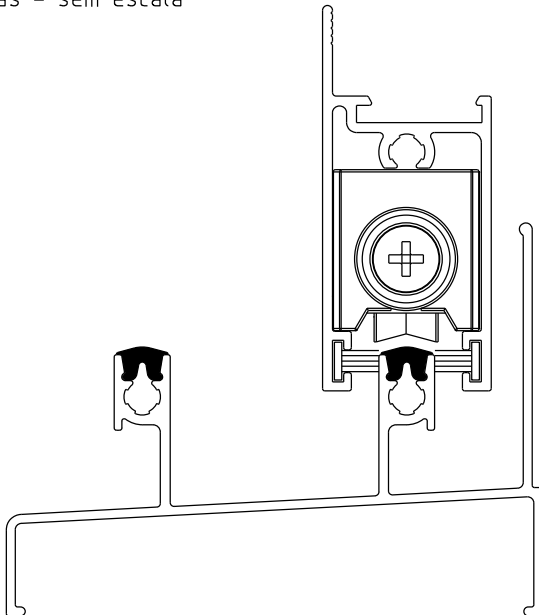

Medidas em milímetros

**Composição**

- Cavalete/suporte da roda nylon c/ fibra
- Rodas c/rolamento nylon/aço bicromatizado
- Parafuso de regulagem M5 x 20 inox
- Parafuso de fixação 3,9 x 13 inox
- Embalagem: 02 pçs

Instalação: escala 1:1