

Maio/2014

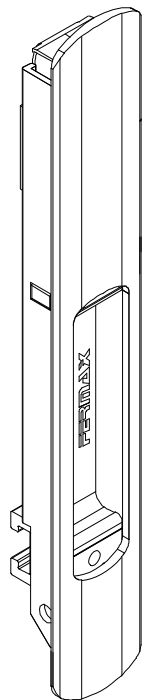

FEC16S manual
FEC37S automático

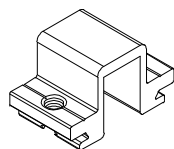

CFE28

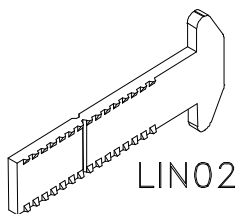

LIN02

Medidas em milímetros

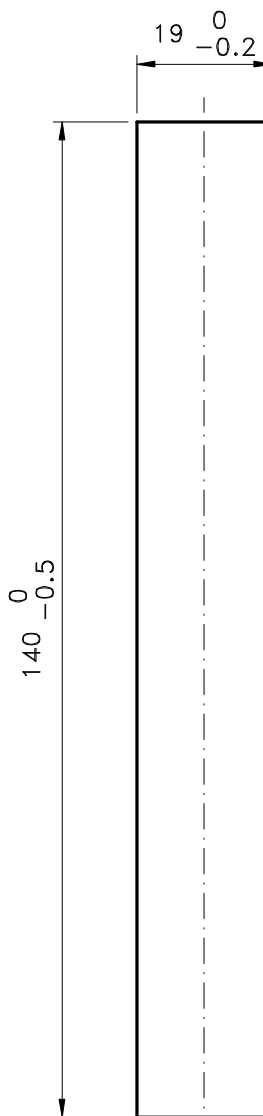

Usinagem - escala 1:1

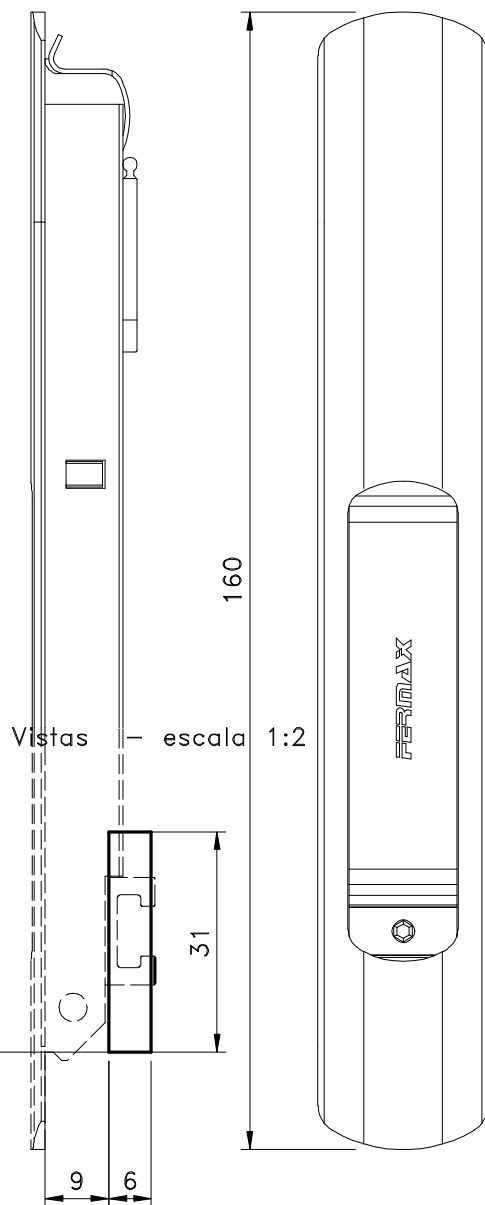
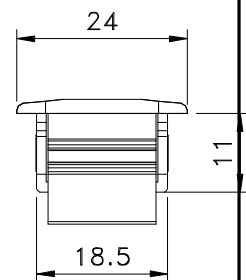

Vistas - escala 1:1

* VENDIDOS SEPARADAMENTE

Composição

Estrutura alumínio
Lingueta/trava aço inox
Mola aço carbono (FEC37S)

* CFE28

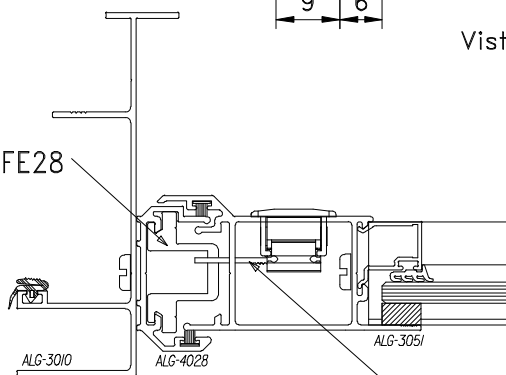

Instalação - escala 1:2