

Junho/2010

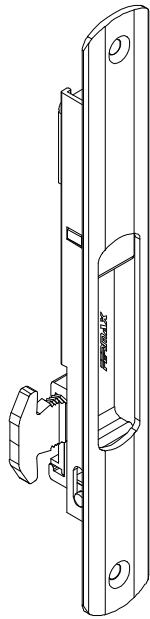

FEC 42 Manual
FEC 43 Automático

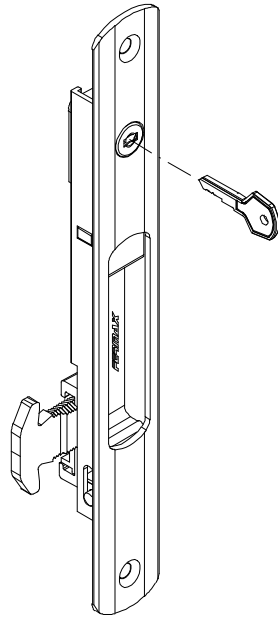

FEC 44 Manual
FEC 45 Automático

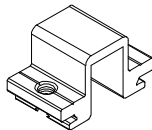

Contra fecho central
CFE28

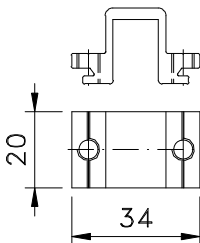

Vistas - sem escala

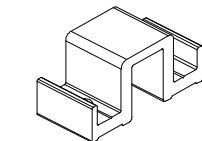

Contra fecho lateral
CFE29

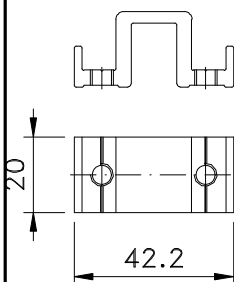

Vistas - sem escala

Composição

- Base alumínio
- Mecanismo poliamida 6.6 e zamak
- Mola aço carbono
- Parafuso M5 x 12 inox

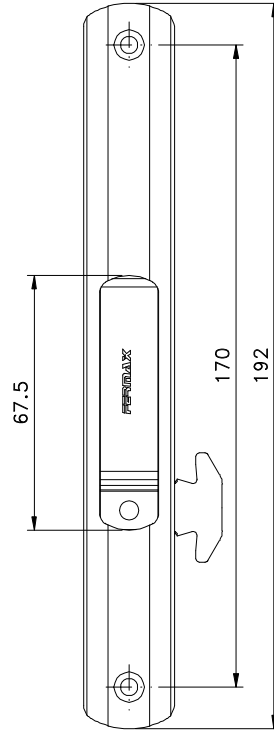
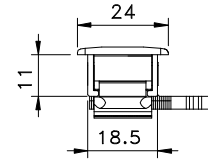
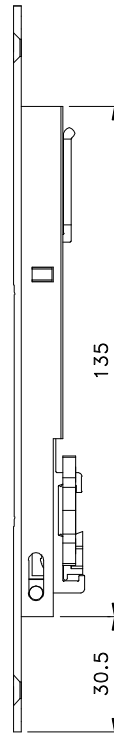

SEM CHAVE

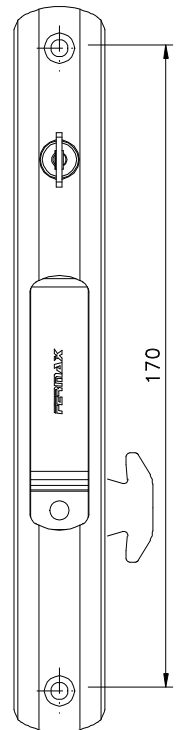

COM CHAVE

Vista - escala 1:2

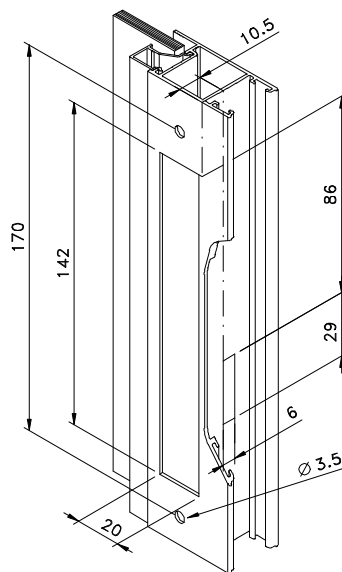

Usinagem para instalação
Sem escala

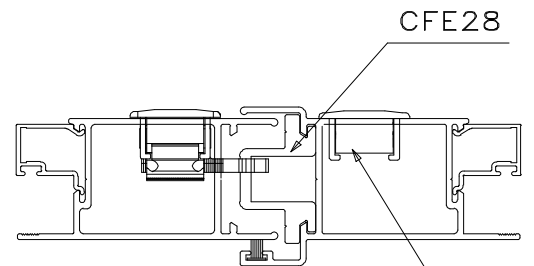
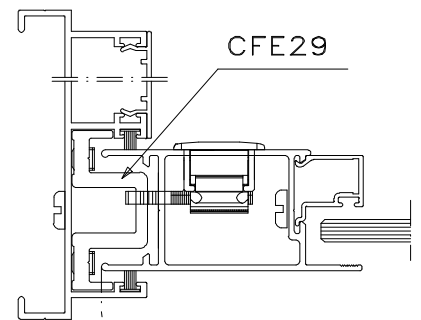

Instalação - escala 1:2

Medidas em milímetros