

FMA 69
FMA 96

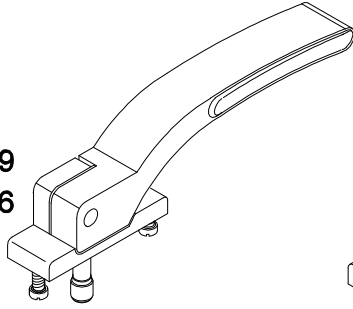

FMA 68

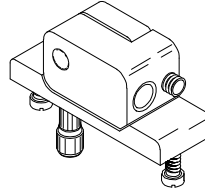

FMA 73

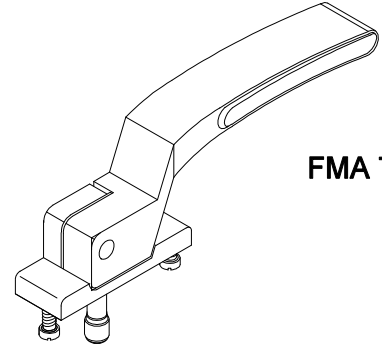

Outubro/2009

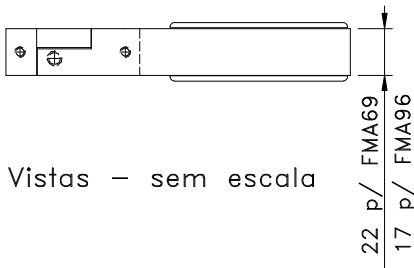
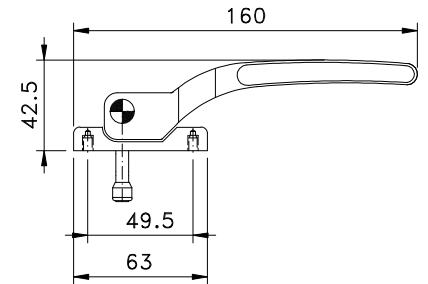
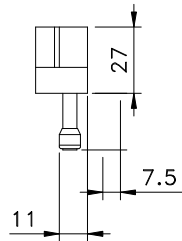
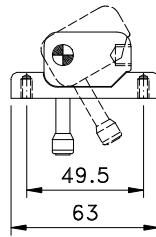
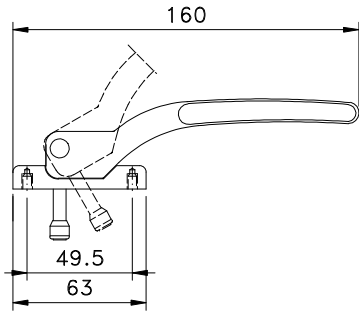

Vistas - sem escala

22 p/ FMA69
17 p/ FMA96

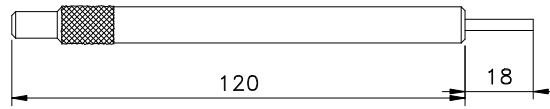
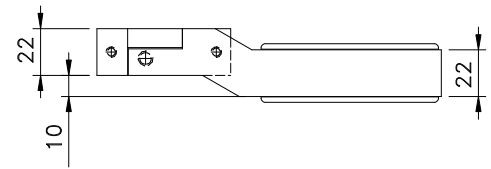

CHA01 - CHAVE P/ FMA68

Medidas em milímetros

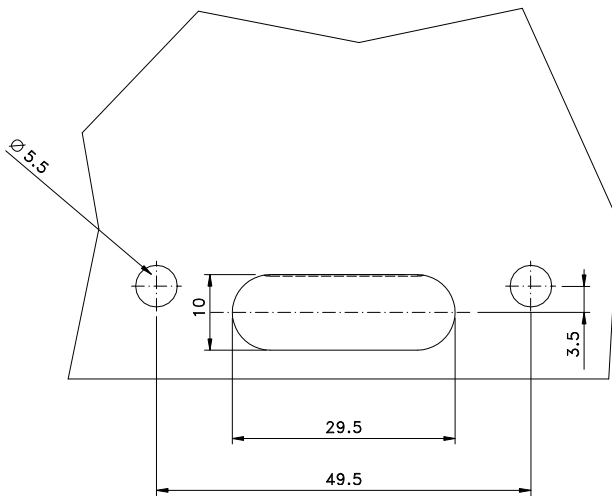

Detalhes de usinagem
Escala 1:1

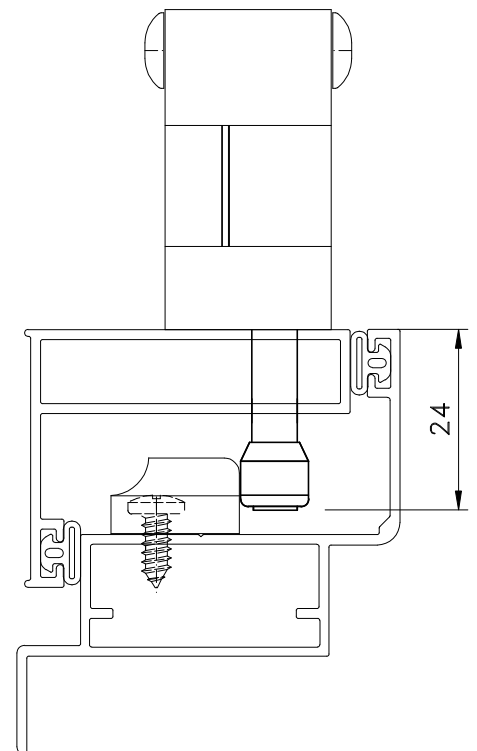

Composição

Base e cabo alumínio
Arremates e contrafecho nylon

Instalação - escala 1:2